

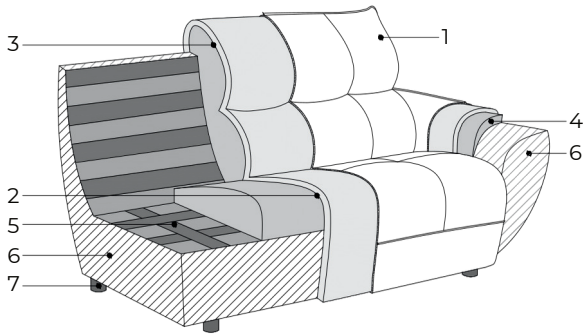

CARATTERISTICHE - CARACTERISTIQUES



1. Rivestimento
Revêtement
2. Imbottitura seduta: poliuretano espanso HT 35 kg/m³ ricoperto con poliuretano espanso SUPER SOFT
Rembourrage assise: polyuréthane expansé HT 35 Kg/m³ recouvert en polyuréthane expansé SUPER SOFT
3. Imbottitura schienale: poliuretano espanso ricoperto con poliuretano espanso SUPER SOFT
Rembourrage dossier: polyuréthane expansé recouvert en polyuréthane expansé SUPER SOFT
4. Imbottitura bracciolo: poliuretano espanso 30 kg/m³ ricoperto con poliuretano espanso SUPER SOFT
Rembourrage accodoir: polyuréthane expansé 30 Kg/m³ recouvert en polyuréthane expansé SUPER SOFT
5. Sistema di molleggio: cinghie elastiche incrociate
Système de suspension: sangles élastiques entrecroisées
6. Struttura portante: legno massello e multistrato con parti in agglomerato
Structure portante: bois massif et panneaux agglomérés ou multicouche
7. Piedi in ABS
Pieds ABS

PIEDI - PIEDS



ABS nero
Pieds ABS noir

Non sfoderabile - Non déhoussable

INFORMAZIONI COMMERCIALI - INFORMATIONS COMMERCIALES

- Ripartizione rivestimento STANDARD
Répartition revêtement STANDARD

● CUS ● FIL ○ STR

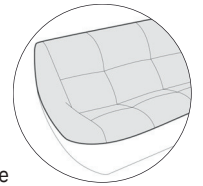

- Le ripartizioni non possono essere modificate
Les répartitions ne peuvent pas être modifiées

- Filetto solo in fettuccia grosgrain
Passepoil disponible seulement dans le liseret grosgrain

- Tutti gli elementi sono rifiniti su tutti i lati
Tous les éléments sont finis sur tous les côtés

- Possibilità di realizzare su misura o personalizzazione
previa valutazione di fattibilità secondo preventivo
Possibilité de personnalisation ou sur mesure après évaluation de
faisabilité et devis au préalable







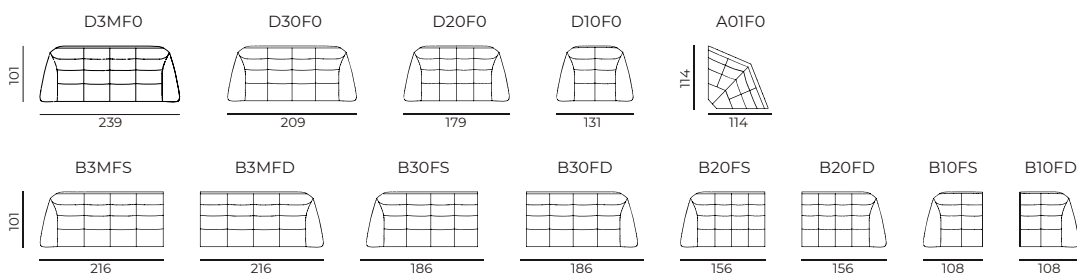

- Le cuciture nelle versioni in pelle possono differire da quelle delle
versioni in tessuto
Les coutures dans les versions en cuir peuvent différer de celles en tissu

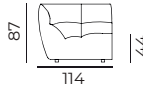
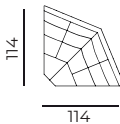
- Le misure d'ingombro possono variare entro un range +/- 4%
L'encombrement maximal peut varier selon une plage de +/- 4%

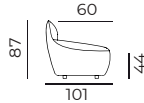
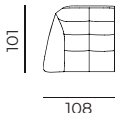
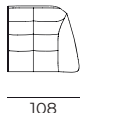
MODULARITA' - MODULARITÉ

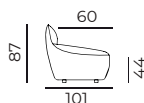
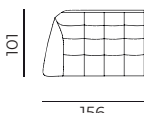
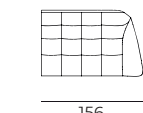
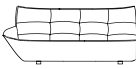
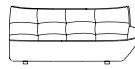
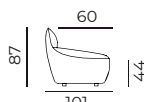
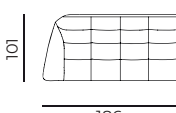
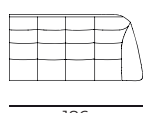

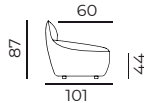
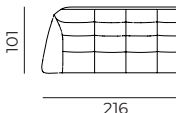
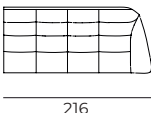
Descrizione Description	Codice Code	Tessuti Tissu	Pelli Cuir
Angolo Angle	A01FO		
		Tessuto Cliente	1295 €
		Cat.A	1295 €
		Cat.B	1330 €
		Cat.C	1390 €
		Cat.D	1450 €
		Cat.E	1498 €
		Cat.F	1630 €
		Cat.G	1752 €
	ml Client Poids Volume	7,50 42 kg 1,40 m3	PROMO CUS Fervor STR Alias 1329 €
Terminale 1 posto dx/sx Batard 1 place droit/gauche	B10FS B10FD		
		Tessuto Cliente	1390 €
		Cat.A	1390 €
		Cat.B	1415 €
		Cat.C	1485 €
		Cat.D	1535 €
		Cat.E	1582 €
		Cat.F	1705 €
		Cat.G	1835 €
	ml Client Poids Volume	6,40 32 kg 1,20 m3	PROMO CUS Fervor STR Alias 1400 €
Terminale 2 posti dx/sx Batard 2 places droit/gauche	B20FS B20FD		
		Tessuto Cliente	1498 €
		Cat.A	1498 €
		Cat.B	1560 €
		Cat.C	1630 €
		Cat.D	1680 €
		Cat.E	1739 €
		Cat.F	1873 €
		Cat.G	2006 €
	ml Client Poids Volume	7,40 52 kg 1,70 m3	PROMO CUS Fervor STR Alias 1546 €
Terminale 3 posti dx/sx Batard 3 places droit/gauche	B30FS B30FD		
		Tessuto Cliente	1690 €
		Cat.A	1690 €
		Cat.B	1753 €
		Cat.C	1824 €
		Cat.D	1884 €
		Cat.E	1946 €
		Cat.F	2091 €
		Cat.G	2236 €
	ml Client Poids Volume	8,30 60 kg 2,00 m3	PROMO CUS Fervor STR Alias 1739 €
Terminale 3 posti maxi dx/sx Batard 3 places maxi droit/gauche	B3MFS B3MFD		
		Tessuto Cliente	1776 €
		Cat.A	1776 €
		Cat.B	1835 €
		Cat.C	1921 €
		Cat.D	1980 €
		Cat.E	2043 €
		Cat.F	2199 €
		Cat.G	2344 €
	ml Client Poids Volume	9,20 68 kg 2,40 m3	PROMO CUS Fervor STR Alias 1824 €

Descrizione Description	Codice Code	Tessuti Tissu	Pelli Cuir
Poltrona Fauteuil 	D10F0 ml Client 7,20 Poids 42 kg Volume 1,50 m3	Tessuto Cliente 1463 €	Cat. 300 2029 €
		Cat.A 1463 €	Cat. 600 2307 €
		Cat.B 1512 €	Cat. 800 2671 €
		Cat.C 1583 €	
		Cat.D 1631 €	
		Cat.E 1679 €	PROMO 1569 €
		Cat.F 1800 €	CUS Fervor STR Alias
Divano 2 posti Canapé 2 place 	D20F0 ml Client 8,60 Poids 62 kg Volume 2,00 m3	Tessuto Cliente 1689 €	Cat. 300 2367 €
		Cat.A 1689 €	Cat. 600 2682 €
		Cat.B 1776 €	Cat. 800 3091 €
		Cat.C 1849 €	
		Cat.D 1909 €	
		Cat.E 1969 €	PROMO 1873 €
		Cat.F 2102 €	
Divano 3 posti Canapé 3 places 	D30F0 ml Client 9,50 Poids 70 kg Volume 2,30 m3	Tessuto Cliente 1801 €	Cat. 300 2500 €
		Cat.A 1801 €	Cat. 600 2839 €
		Cat.B 1861 €	Cat. 800 3285 €
		Cat.C 1946 €	
		Cat.D 2006 €	
		Cat.E 2066 €	PROMO 1969 €
		Cat.F 2222 €	CUS Fervor STR Alias
Divano 3 posti maxi Canapé 3 places maxi 	D3MF0 ml Client 10,40 Poids 78 kg Volume 2,60 m3	Tessuto Cliente 1946 €	Cat. 300 2719 €
		Cat.A 1946 €	Cat. 600 3105 €
		Cat.B 2006 €	Cat. 800 3599 €
		Cat.C 2013 €	
		Cat.D 2174 €	
		Cat.E 2236 €	PROMO 2052 €
		Cat.F 2424 €	CUS Fervor STR Alias

La versione Promo prevede esclusivamente la cuscineria in tessuto Fervor e la struttura in tessuto Alias
 La version Promo prévoit exclusivement le coussinage en tissu Fervor et la structure en tissu Alias